

LAQUA



pH	ORP	Ion	Conductivity
Resistivity	TDS	DO	Salinity

Handheld Water Quality Meters
LAQUAact 100 Series



www.horiba-laqua.com



LAQUA^{act}

In the lab, in the field or anywhere you need it
100 Series Water Quality Instruments



Easy to carry

The compact and ergonomic design is easy to carry and includes an electrode hook attachment that allows up to 2 electrodes to be attached on either side of the meter.



Shock-resistant

Polycarbonate resin* used in automobiles and mobile phones has been adopted to enhance shock resistance. *Polycarbonate resin has about twice the shock resistance of conventional ABS resin.



Waterproof and dustproof

IP67 rated waterproof and dustproof casing. *IP67: Fully waterproof for approximately 30 minutes in 1 meter of water.

Rugged carry-case

Moulded carry-case houses meter as well as the sensors, calibrating solutions, manuals, batteries. Convenient for field measurement and safe storage place for meter and accessories

9651-10D plastic body gel-filled electrode

- pH range 0 to 14
- temp range 0 to 60°C
- Porous sintered polyethylene liquid junction
- With integrated temperature sensor
- Waterproof, Lead-free glass
- 1m cable with BNC & phono jack connectors



Extended operation

Uses about 10% of the power compared to conventional meters. With up to 1000 hrs of use, long periods of field work is possible.

CAL MEAS DATA



One hand operation

Slim body fits in your hand. Only three basic operation buttons for one-hand operability.



Auto Hold or Auto-Stable functions

- In auto hold mode, meter freezes LCD when readings are stable
- Auto-stable mode continuously refreshes readings on LCD with stability indicator

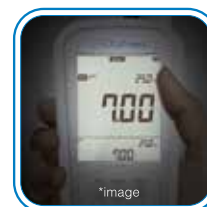

Large LCD screen

- Large 64mm by 52mm screen allows for clear view of readings, diagnostic messages
- Backlight available in selected models

Visible LCD in dark places

Backlight allows reading of measured values even in the dark.

Dual-display screen (PH 130, PC 110 & PD 110)

- Dual channel meters feature dual display screen
- Simultaneous independent measurements of both channels
- Independent setup for each channel

TDS calibration curves

TDS models include predetermined standard curves for more accurate TDS readings across the measurement range. For convenience, calibration is only performed in EC mode.

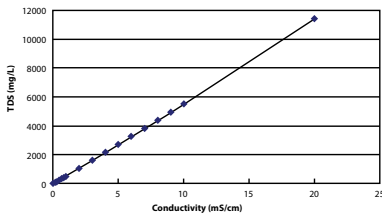
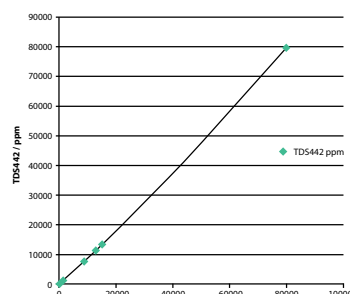
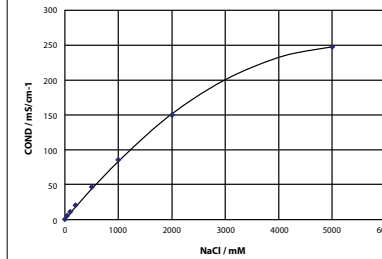
Application	Environmental	Boiler water, HVAC	Aquaculture, pickling
Key chemical species	EN standard for environmental water	Na ₂ SO ₄ , NaHCO ₃ , NaCl	NaCl
TDS selection	EN27888 curve 	442 (Myron) curve 	NaCl curve 

pH Meters

PH 110

PH 120

PH 130

Model	PH 110 pH/ORP/Temp (°C)	PH 120 pH/ORP/Temp (°C)	PH 130 Dual Channel pH/ORP/Ion/Temp (°C)
pH range	-2.00 to 16.00 pH	-2.00 to 16.00 pH	-2.00 to 16.00 pH
Resolution	0.01 pH	0.01 pH	0.01 pH
Accuracy	±0.01 pH	±0.01 pH	±0.01 pH
Cal points	5	5	5
Buffer options	USA, NIST	USA, NIST, Custom	USA, NIST, Custom
ORP range	±2000 mV	±2000 mV	±2000 mV
Resolution	1 mV	1 mV	1 mV
Accuracy	±1 mV or 1% of reading (whichever is greater)	±1 mV or 1% of reading (whichever is greater)	±1 mV or 0.2% of reading (whichever is greater)
Ion range	—	—	0.00 µg/l to 1999 g/l
Resolution	—	—	3 significant digits
Accuracy	—	—	±0.8% full scale
Cal points	—	—	Up to 5
Temperature range	-30.0 °C to 130 °C	-30.0 °C to 130 °C	-30.0 °C to 130 °C
Resolution	0.1 °C	0.1 °C	0.1 °C
Accuracy	±0.4 °C	±0.4 °C	±0.4 °C
Cal option	Yes	Yes	Yes
Memory	100	1000	1000
Data-logging	—	Yes	Yes
Real time clock	—	Yes	Yes
Date/time stamping	—	Yes	Yes
Auto Shut-off	Yes (programmable: 1 to 30 mins)	Yes (programmable: 1 to 30 mins)	Yes (programmable: 1 to 30 mins)
Auto-Hold	Yes	Yes	Yes
Averaging/ Stability	Yes, Automatic	Yes, Automatic	Yes, Automatic
Offset display	Yes	Yes	Yes
Slope display	Yes (independent acid and alkaline slopes depending on calibration)	Yes (independent acid and alkaline slopes depending on calibration)	Yes (independent acid and alkaline slopes depending on calibration)
Cal Alarm	—	Yes (programmable: 1 to 400 days)	Yes (programmable: 1 to 400 days)
Electrode status	On screen display	On screen display	On screen display
Diagnostic messages	Yes	Yes	Yes
Display	Custom LCD	Custom LCD with backlight	Custom LCD with backlight
Inputs	BNC, phono, DC sockets	BNC, phono, DC sockets	2 x BNC, 2 x phono, DC sockets
Outputs	—	RS232C	RS232C
IP rating	IP67, shock resistant	IP67, shock resistant	IP67, shock resistant
Power requirements	2 x 'AAA' or LR03 or Ni-H rechargeable batteries or power adaptor	2 x 'AAA' or LR03 or Ni-H rechargeable batteries or power adaptor	2 x 'AAA' or LR03 or Ni-H rechargeable batteries or power adaptor
Battery life	> 1000 hrs	> 1000 hrs	> 500 hrs

Kit* includes:	PH110-K Waterproof pH/ORP handheld meter (3999960167)	PH120-K Waterproof pH/ORP handheld data meter (3999960168)	PH130-K Waterproof pH/ORP/Ion handheld data meter (3999960169)
	<ul style="list-style-type: none"> PH110 meter 9651-10D plastic-body, gel-filled pH electrode pH 4.01, 7.00, 10.01 solutions (60ml) carry case 	<ul style="list-style-type: none"> PH120 meter 9651-10D plastic-body, gel-filled pH electrode pH 4.01, 7.00, 10.01 solutions (60ml) carry case 	<ul style="list-style-type: none"> PH130 meter 9651-10D plastic-body, gel-filled pH electrode pH 4.01, 7.00, 10.01 solutions (60ml) carry case

*Kit with NIST buffers set is available upon request. Add 'N' suffix to order code when ordering



Model	EC 110 EC/TDS/Res/Temp (°C)	EC 120 EC/TDS/Res/Sal/Temp (°C)
EC range	.. µS/cm to 200.0 mS/cm (@ k=1.0)	.. µS/cm to 2000.0 mS/cm
Resolution	0.05% F.S.	0.05% F.S.
Accuracy	±0.6% F.S.; ±1.5% F.S. > 18.0 mS/cm	±0.6% F.S.; ±1.5% F.S. > 18.0 mS/cm
Ref. temp.	15 to 30 °C (adjustable)	15 to 30 °C (adjustable)
Temp. compensation	0.0 to 10.0% (adjustable)	0.0 to 10.0% (adjustable)
Cell constants	0.1 / 1.0 / 10.0	0.1 / 1.0 / 10.0
Cal points	4 points (Auto/Manual)	4 points (Auto/Manual)
Units setting	Auto ranging / Manual µS/cm or mS/cm or S/m	Auto ranging / Manual µS/cm or mS/cm or S/m
TDS range	... ppm to 100 ppt (TDS factor @ 0.5)	... ppm to 1000 ppt (TDS factor @ 0.5)
Resolution	0.01ppm / 0.1 ppt	0.01ppm / 0.1 ppt
Accuracy	±0.1% F.S.	±0.1% F.S.
TDS curves	EN27888, 442, linear (0.40 to 1.0), NaCl	EN27888, 442, linear (0.40 to 1.0), NaCl
Resistivity Range	0.000 Ω/cm to 200.0 MΩ/cm	0.000 Ω/cm to 200.0 MΩ/cm
Resolution	0.05% F.S.	0.05% F.S.
Accuracy	0.6% F.S. ±1.5% F.S. > 1.80 MΩ/cm	0.6% F.S. ±1.5% F.S. > 1.80 MΩ/cm
Salinity	—	0.0 to 100.0 ppt 0.00 to 10.00 %
Resolution	—	0.1 ppt / 0.1%
Accuracy	—	0.2% F.S.
Cal curves	—	NaCl / Sea water
Temperature range	-30.0 °C to 130 °C	-30.0 °C to 130 °C
Resolution	0.1 °C	0.1 °C
Accuracy	±0.4 °C	±0.4 °C
Memory	100	1000
Data-logging	—	Yes
Real time clock	—	Yes
Date/time stamping	—	Yes
Auto Shut-off	Yes (programmable: 1 to 30 mins)	Yes (programmable: 1 to 30 mins)
Auto-Hold	Yes	Yes
Diagnostic messages	Yes	Yes
Display	Custom LCD	Custom LCD with backlight
Inputs	BNC, phono, DC sockets	BNC, phono, DC sockets
Outputs	—	RS232C
IP rating	IP67, shock resistant	IP67, shock resistant
Power requirements	2 x 'AAA' or LR03 or Ni-H rechargeable batteries or power adaptor	2 x 'AAA' or LR03 or Ni-H rechargeable batteries or power adaptor
Battery life	> 200 hrs	> 200 hrs

Kit includes:	EC110-K Waterproof EC/TDS/Res handheld meter (3999960170) <ul style="list-style-type: none"> • EC110 meter • 9382-10D plastic-body, Titanium/Platinum black, conductivity cell, k=1.0 • 84µS/cm, 1413 uS/cm, 12.88 mS/cm, 111.8 mS/cm solutions (60ml) • carry case 	EC120-K Waterproof EC/TDS/Res/Sal handheld data meter (3999960171) <ul style="list-style-type: none"> • EC120 meter • 9382-10D plastic-body, Titanium/Platinum black, conductivity cell, k=1.0 • 84µS/cm, 1413 uS/cm, 12.88 mS/cm, 111.8 mS/cm solutions (60ml) • carry case
---------------	---	--

Dissolved Oxygen Meters



Model	DO 110	DO 120
	DO / Temp (°C)	DO / Temp (°C)
Dissolved Oxygen range	0.0 to 20.00 mg/l 0.0 to 200.0%	0.0 to 20.00 mg/l 0.0 to 200.0%
Resolution	0.01 mg/l or 0.1%	0.01 mg/l or 0.1%
Accuracy	±0.1 mg/l	±0.1 mg/l
Salinity compensation	0 to 40 ppt	0 to 40 ppt
Barometric pressure compensation	Yes	Yes
DO Probe type	Galvanic with integrated temperature sensor	Galvanic with integrated temperature sensor
Calibration	1 or 2 points	1 or 2 points

Temperature range	-30.0 °C to 130 °C	-30.0 °C to 130 °C
Resolution	0.1 °C	0.1 °C
Accuracy	±0.4 °C	±0.4 °C

Memory	100	1000
Data-logging	—	Yes
Real time clock	—	Yes
Date/time stamping	—	Yes
Auto Shut-off	Yes (programmable: 1 to 30 mins)	Yes (programmable: 1 to 30 mins)
Auto-Hold	Yes	Yes
Diagnostic messages	Yes	Yes
Display	Custom LCD	Custom LCD with backlight
Inputs	BNC, phono, DC sockets	BNC, phono, DC sockets
Outputs	—	RS232C
IP rating	IP67, shock resistant	IP67, shock resistant
Power requirements	2 x 'AAA' or LR03 or Ni-H rechargeable batteries or power adaptor	2 x 'AAA' or LR03 or Ni-H rechargeable batteries or power adaptor
Battery life	> 500 hrs	> 500 hrs

Kit includes:	DO110-K Waterproof Dissolved Oxygen meter (3999960172) <ul style="list-style-type: none"> • DO110 meter • 9551-20D Galvanic DO probe, 2m cable • carry case 	DO120-K Waterproof Dissolved Oxygen data meter (3999960173) <ul style="list-style-type: none"> • DO120 meter • 9551-20D Galvanic DO probe, 2m cable • carry case
---------------	--	---



PC 110

PD 110

Models	PC 110	PD 110
	Dual Channel pH/ORP/ EC/TDS/Res/Sal/Temp (°C)	Dual Channel pH/ORP/ DO/Temp (°C)
pH range	-2.00 to 16.00 pH	-2.00 to 16.00 pH
Resolution	0.01 pH	0.01 pH
Accuracy	±0.01 pH	±0.01 pH
Cal points	5	5
Buffer options	USA, NIST, Custom	USA, NIST, Custom
ORP range	±2000 mV	±2000 mV
Resolution	1 mV	1 mV
Accuracy	±1 mV or 1% of reading (whichever is greater)	±1 mV or 1% of reading (whichever is greater)
Dissolved Oxygen range	—	0.0 to 20.00 mg/l 0.0 to 200.0%
Resolution	—	0.01 mg/l or 0.1%
Accuracy	—	±0.1 mg/l
Salinity compensation	—	0 to 40 ppt
Barometric pressure compensation	—	Yes
DO Probe type	—	Galvanic with integrated temperature sensor
Calibration	—	1 or 2 points
EC range	... µS/cm to 2000.0 mS/cm	—
Resolution	0.05% F.S.	—
Accuracy	±0.6% F.S.; ±1.5% F.S. > 18.0 ms/cm	—
Ref. temp.	15 to 30 °C (adjustable)	—
Temp. compensation	0.0 to 10.0% (adjustable)	—
Cell constants	0.1 / 1.0 / 10.0	—
Cal points	4 points (Auto/Manual)	—
Units setting	Auto ranging / Manual µS/cm or mS/cm or S/m	—
TDS range	... ppm to 1000 ppt (TDS factor @ 0.5)	—
Resolution	0.01ppm / 0.1 ppt	—
Accuracy	±0.1% F.S.	—
TDS curves	EN27888, 442, linear (0.40 to 1.0), NaCl	—
Resistivity Range	0.000 Ω/cm to 200.0 MΩ/cm	—
Resolution	0.05% F.S.	—
Accuracy	0.6% F.S. ±1.5% F.S. > 1.80 MΩ/cm	—
Salinity	0.0 to 100.0 ppt 0.00 to 10.00 %	—
Resolution	0.1 ppt / 0.1%	—
Accuracy	0.2% F.S.	—
Cal curves	NaCl / Sea water	—
Memory	1000	1000
Data-logging	Yes	Yes
Real time clock	Yes	Yes
Date/time stamping	Yes	Yes
Auto Shut-off	Yes (programmable: 1 to 30 mins)	Yes (programmable: 1 to 30 mins)
Auto-Hold	Yes	Yes
Averaging/Stability	Yes, Automatic	Yes, Automatic
Offset display	Yes	Yes
Slope display	Yes (independent acid and alkaline slopes depending on calibration)	Yes (independent acid and alkaline slopes depending on calibration)
Cal Alarm	Yes (programmable: 1 to 400 days)	Yes (programmable: 1 to 400 days)
Electrode status	On screen display	On screen display
Diagnostic messages	Yes	Yes
Display	Custom LCD with backlight, Dual channel	Custom LCD with backlight, Dual channel
Inputs	Dual BNC, phono, DC sockets	Dual BNC, phono, DC sockets
Outputs	RS232C	RS232C
IP rating	IP67, shock resistant	IP67, shock resistant
Power requirements	2 x 'AAA' or LR03 or Ni-H rechargeable batteries or power adaptor	2 x 'AAA' or LR03 or Ni-H rechargeable batteries or power adaptor
Battery life	> 200 hrs	> 500 hrs
Kit* includes:	PC110-K Waterproof pH/ORP/EC/TDS/Res/Sal handheld data meter (3999960174) • PC110 meter • 9651-10D plastic gel-filled pH electrode • 9382-10D plastic-body, Titanium/Platinum black, conductivity cell, k=1.0 • pH 4.01, pH7.00, 1413 uS/cm, 12.88 mS/cm solutions (60ml) • carry case	PD110-K Waterproof pH/ORP/DO handheld data meter (3999960175) • PD110 meter • 9651-10D plastic gel-filled pH electrode • 9551-20D Galvanic DO probe, 2m cable • pH 4.01, 7.00, 10.01 solutions (60ml) • carry case

*Kit with NIST buffers set is available upon request. Add 'N' suffix to order code when ordering

pH Solution Kits

Name	Type	Specification	Volume	Part No.
NIST pH Buffer Solution Kit	501-S	(4.01/6.86/9.18/3.33M KCl)	250ml ea	3999960015
USA pH Buffer Solution Kit	502-S	(4.01/7.00/10.01/3.33M KCl)	250ml ea	3999960016

pH Solutions

Name	Type	Specification	Volume	Part No.
Buffer Solution at 25°C	500-2	pH 1.68	500ml	3999960028
	500-4	pH 4.01	500ml	3999960029
	500-686	pH 6.86	500ml	3999960030
	500-7	pH 7.00	500ml	3999960031
	500-9	pH 9.18	500ml	3999960032
	500-10	pH 10.01	500ml	3999960033
	500-12	pH 12.46	500ml	3999960034

Conductivity Solution Kit

Name	Type	Specification	Volume	Part No.
Conductivity Standard Solution Kit	503-S	(84 uS/cm; 1413 uS/cm; 12.88 mS/cm; 111.8 mS/cm)	250ml ea	3999960017

Conductivity Solutions

Name	Type	Specification	Volume	Part No.
Conductivity Standard Solution at 25°C	500-21	84 uS/cm	500ml	3999960035
	500-22	1413 uS/cm	500ml	3999960036
	500-23	12.88 mS/cm	500ml	3999960037
	500-24	111.8 mS/cm	500ml	3999960038

Accessories

Name	Description	Part No.
Printer (for GLP / GMP compliance)	US version 120V (does not include printer cable)	3014030146
	EU version 230V (does not include printer cable)	3014030147
Printer cable	1.5 m	3014030148
Printer paper	20 rolls	3014030149
Ink ribbon	5 pcs/set	3014030150
Universal AC adapter	Multi-voltage (100-240V) with 6 plugs, 1.5m cable	3200647413
Digital simulator X-51	pH, mV, Ion, DO simulator	3014028368
Digital simulator X-52	Conductivity simulator	3014028370
Serial cable	Cable to connect meter and PC (Serial, 9 pins)	3014030151
Electrode hook	With function for winding the cable	3200528475
DP-70S Electrode stand (adjustable type)	With holder for D/ES/OM-70	3200528474



pH Buffer Solutions



Conductivity Standard Solutions

Electrode Cleaning Solutions

- For removing inorganic sample residues from glass electrodes, and for cleaning liquid junctions

Name	Type	Volume (ml)	Part No.
Cleaning Solution	220	50 x 2 pcs	3014028653

- For removing protein containing sample residues from glass electrodes, and for cleaning liquid junctions.

Name	Type	Volume (ml)	Part No.
Cleaning Solution	250	400	3200366771



Printer (for GLP / GMP compliance)



Universal Adapter with 6 plugs



Digital simulator

Electrodes*

Name	Description	Part No.
9651-10D	Plastic-body, gel-filled pH electrode with integrated temperature sensor	3200642020
9382-10D	Plastic-body, k=1.0 conductivity cell, Titanium / Platinum black, with integrated temperature sensor	3014046709
9551-20D	Galvanic DO probe with integrated temperature sensor and 2m cable	3014047090

*Electrodes carry a 6-month warranty against manufacturing defects only

Dimensions Unit: mm

100 Series / D-70 Series /
ES-70 Series / OM-70 Series

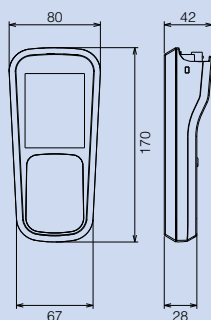

Electrode Stand (DP-70S)

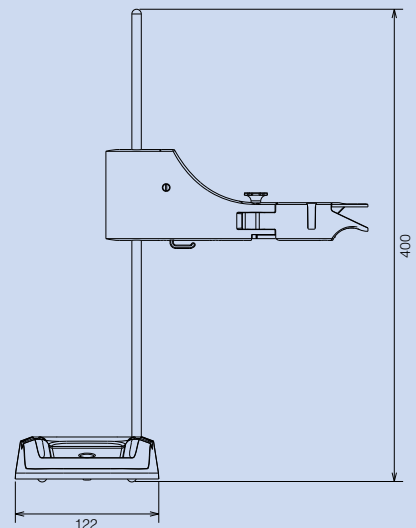
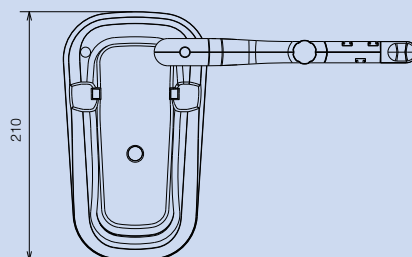

With over 60 years of engineering excellence, HORIBA's diverse range of water quality analyzers and electrodes are ideal for everyday laboratory needs through to the most demanding of applications. Visit our website for a wealth of useful information and water quality measurement tips to help you obtain the best results in your work.



Electrodes

HORIBA's superior electrode technology has been employed in manufacturing our unparalleled tough pH glass bulbs and unique flat sensors. Our electrodes have different designs to cater a wide range of applications—from pure water to complex samples. Select the suitable electrode that is specially designed for your application.



Bench Meters

Developed using extensive feedback from users, our new LAQUA meters deliver the best solution for water quality analysis. Our LAQUA website features an online 'Selection Guide' to enable you to find the perfect LAQUA meter and electrode for your need.



Pocket Meters

Analyzing water quality is simplified when using our LAQUAtwin range of meters. Designed to produce accurate and reliable results. Anyone, anywhere, at any time can measure samples easily with a LAQUAtwin meter. See just how good they are at our website.

Application Notes

LAQUAtwin pocket meters offer quick and convenient alternative to analyze important parameters with high accuracy. Several application notes are available at (<http://goo.gl/znwE6j>) detailing the use of LAQUAtwin and the results achieved for the respective applications. Additional application notes will be added when available.

SUPPORT HORIBA CUSTOMER SUPPORT SYSTEM

HORIBA offers a variety of services to conform to quality standards and international guidelines such as GLP, GMP and ISO

Technical Support

Please contact us with any technical questions about our products.

www.horiba.com/wq/support

User Support

Our support website is available for registered customers and features:

- Data collection software
- Instruction manual downloads
- Measurement tips, etc.

www.horiba.co.jp/register

Validation Support

Please contact us with any questions or requirements for your validation procedure.

- Traceability certification*
- IQ/OQ/PQ support*
- SOP guidance
- FAQ

*Optional services

Please read the operation manual before using this product to assure safe and proper handling of the product.

- The contents of this catalog are subject to change without prior notice, and without any subsequent liability to this company.
- The color of the actual products may differ from the color pictured in this catalog due to printing limitations.
- It is strictly forbidden to copy the content of this catalog in part or in full.
- All brand names, product names and service names in this catalog are trademarks or registered trademarks of their respective companies.
- Windows is a registered trademark of Microsoft Corporation in the United States and other countries.

<http://www.horiba.com> e-mail: laqua@horiba.com

HORIBA Instruments (Singapore) Pte. Ltd.
 83 Science Park Drive
 #02-02A, The Curie
 Singapore 118258
 Phone: 65 6908-9660
 Fax: 65 6745-8155



Brochure HBT-09-2015B